

1	2	3	4	5	6	7	8				
THIS DRAWING AND THE DATA DISCLOSED HEREIN OR HEREWITH IS NOT TO BE REPRODUCED USED OR DISCLOSED IN WHOLE OR IN PART TO ANYONE WITHOUT THE PERMISSION OF JESS-LINK PRODUCTS CO.,LTD.(JPC)				CUSTOMER DRAWING DRWC-007698		REV.	ECN NO.	DESCRIPTION	MDF'D	APP'D	DATE
						01		INITIAL DESIGN	Philip	Richard	06/29/2023
						02					
						03					

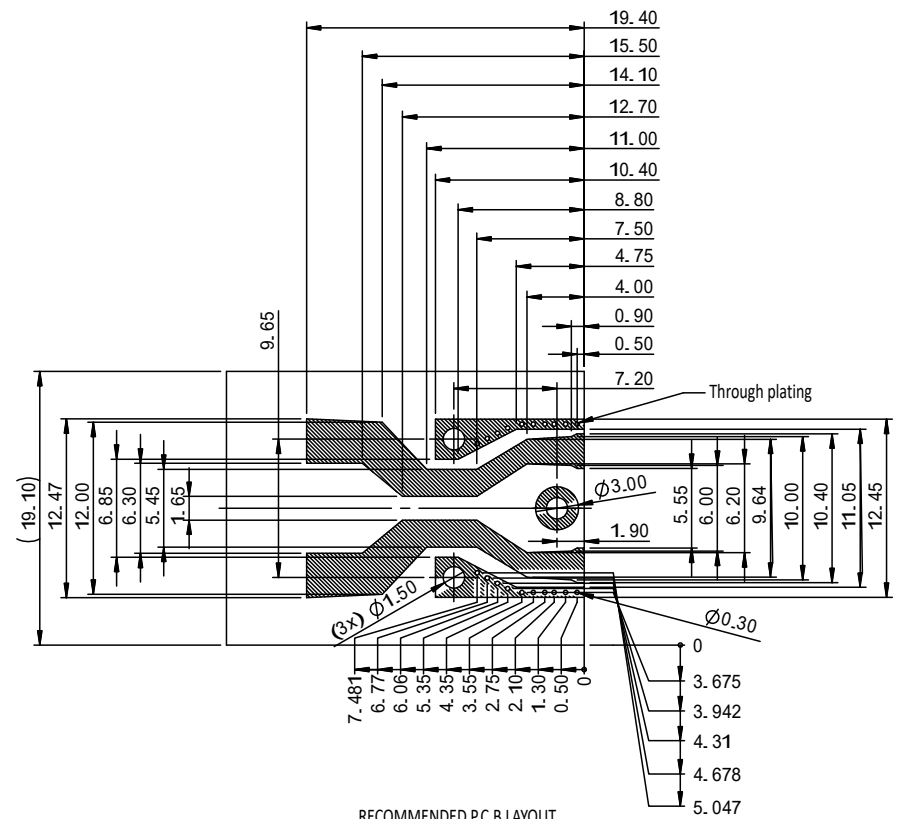
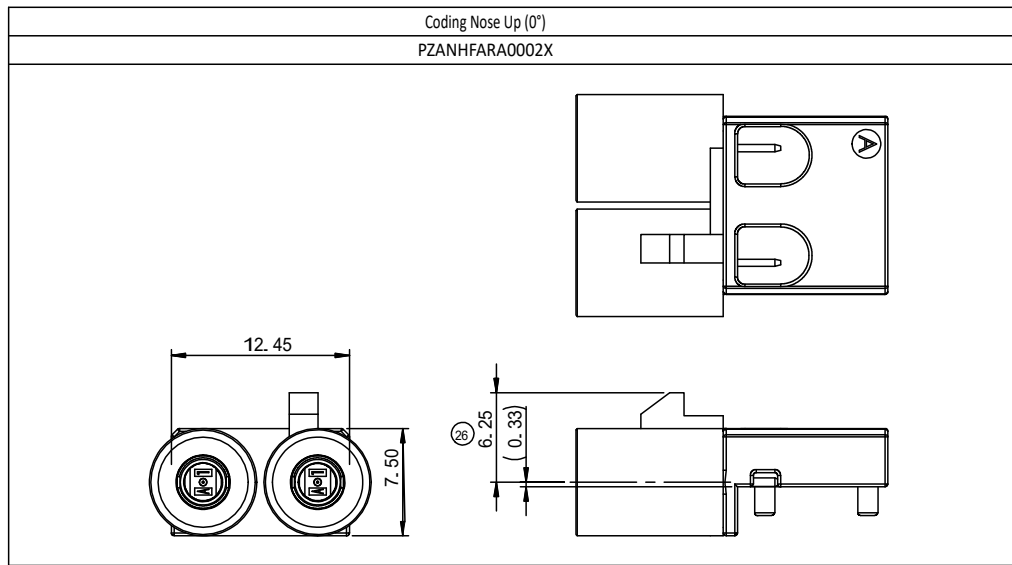
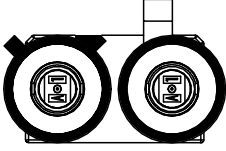
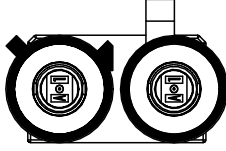
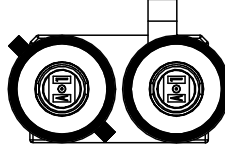
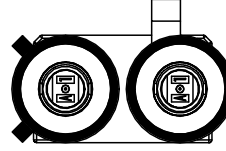
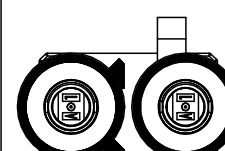
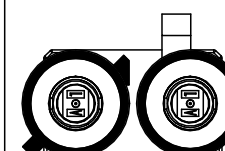
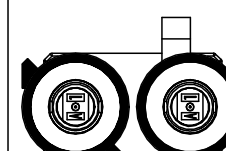

RECOMMENDED P.C.B LAYOUT
Still under investigation
For FR4/1.50mm thickness
TOLERANCE: ±0.05mm

RoHS COMPLIANT	Unit:mm(inch)	PROJECTION	JPC connectivity	
	GENERAL TOLERANCES: (UNLESS SPECIFIED)	D.R. 06/29/2023	TITLE	PD./FILE NO.
	0 = ±1 (0.039)	Philip	Fakra Twin R/A Plug X-Code PCB Mid-mount, CH=0.33mm	
	0.0 = ±5 (0.02)	CH.K 06/29/2023	SCALE	REV. 01
0.00 = ±.3 (0.012)	Philip	SIZE	PART NO.	
0.000 = ±.15 (0.006)	APV.D 06/29/2023	3:1	A4	PZANHFARA0002X
0° = ± 2°	Richard			SHEET 2 OF 3
0.0° = ± 1°				

Codings							
Coding	A	B	C	D	H	I	N
Plug							
Color	Black	Cream White	Blue	Bordeaux	Violet	Beige	Pastel Green

KEY	Product Name	Color	P/N.
A	Fakra Twin R/A Plug A-Code , PCB Mid-mount , CH=0.33mm	Black	PZANHFARA0002A
B	Fakra Twin R/A Plug B-Code , PCB Mid-mount , CH=0.33mm	Cream White	PZANHFARA0002B
C	Fakra Twin R/A Plug C-Code , PCB Mid-mount , CH=0.33mm	Blue	PZANHFARA0002C
D	Fakra Twin R/A Plug D-Code , PCB Mid-mount , CH=0.33mm	Bordeaux	PZANHFARA0002D
H	Fakra Twin R/A Plug H-Code , PCB Mid-mount , CH=0.33mm	Violet	PZANHFARA0002H
I	Fakra Twin R/A Plug I-Code , PCB Mid-mount , CH=0.33mm	Beige	PZANHFARA0002I
N	Fakra Twin R/A Plug N-Code , PCB Mid-mount , CH=0.33mm	Pastel Green	PZANHFARA0002N

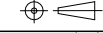
RoHS COMPLIANT	Unit:mm(inch)	PROJECTION 	JPC connectivity	
	GENERAL TOLERANCES: (UNLESS SPECIFIED)	D.R. 06/29/2023 Philip	TITLE	PD./FILE NO.
	0 =±1 (0.039) 0.0 =±.5 (0.02) 0.00 =±.3 (0.012) 0.000=±.15(0.006)	CH.K 06/29/2023 Philip	Fakra Twin R/A Plug X-Code PCB Mid-mount , CH=0.33mm	
	0° =± 2' 0.0° =± 1'	APV.D 06/29/2023 Richard	SCALE	REV. 01
		SIZE	PART NO.	SHEET 3 OF 3
		3:1	A4	PZANHFARA0002X